

RAY



 **RAPHAEL**
BY TALIS

RAPHAEL

is a privately owned company operating from its manufacturing base in Israel. Founded in 1949, the company supplies quality valves to local as well as international markets.

RAPHAEL's wide product range is extensively used in industry, urban water supply, power plants, irrigation, etc.

The company's plant, located in a modern facility, utilizes state of the art equipment in its machining department.

The coating department includes enamel, epoxy paint and nylon (rilsan) facilities.

Rilsan



email

50 years of experience



All products are subject to stringent quality control procedures during manufacture and assembly.

RAPHAEL's professional work-force and technical engineering team are all highly skilled, trained and experienced in their respective fields. One of the company's major assets, our R&D Department constantly strives to introduce new and innovative products.

The winning combination of state-of-the-art technology and accumulated know-how enables RAPHAEL to offer its customers various solutions for different needs in a wide range of areas, including short run production, large diameter articles and high pressure products.

The various coatings give us the ability to supply high standard finishes for special purposes. All products have to pass strict pressure tests in the company's testing plant.



RAPHAEL produces a wide variety of products, including butterfly valves, check valves, gate valves, globe valves, hydraulic control valves, fire hydrants, strainers, filters, etc.

In 1993

RAPHAEL launched "RAF"- a new series of hydraulic valves consisting three basic parts: body, cover and diaphragm.

Simple and compact -cost effect.

The "No Spring" valve ensures longer diaphragm life and even distribution of pressure on the sealing area, and prevents diaphragm deformation. The valves contain a minimum number of moving parts and require no maintenance.



New diaphragm - no spring required for operation.

The unique rib-styled diaphragm has several advantages. Opening and closing of the diaphragm is gradual, which eliminating water hammer, vibration and noise.

Smooth pressure regulation even in low flow condition.

RAF valves provide accurate pressure regulation at low flow rates. Full valve opening is obtained at a very low pressure. One diaphragm controls the whole pressure range.

Today

RAPHAEL is proud to present the new and improved high performance hydraulic control valve - "RAY".



No spring required for operation.

This "No Spring" control valve has a double-chamber rubber fabric diaphragm. The new design consists of one universal plug in each size which suits all application (as opposed to other products in which a complex shape or range of shapes are used, depending on the type of liquid and the level of control required).

Easy maintenance.

The plug is made of hard rubber on steel core and has a special profile allowing very fine flow regulation. The combination of a special plug, a stainless steel seat and a unique body design enables practically cavitation free operation.

Very low pressure drop.

The new plug combined with the overall hydro-dynamic design reduces headloss to a minimum, it allows fine regulation and quick response, even at minimal flow rates.

Quiet in operation.

The plug prevents valve hiss and eliminates vibration in the valve.

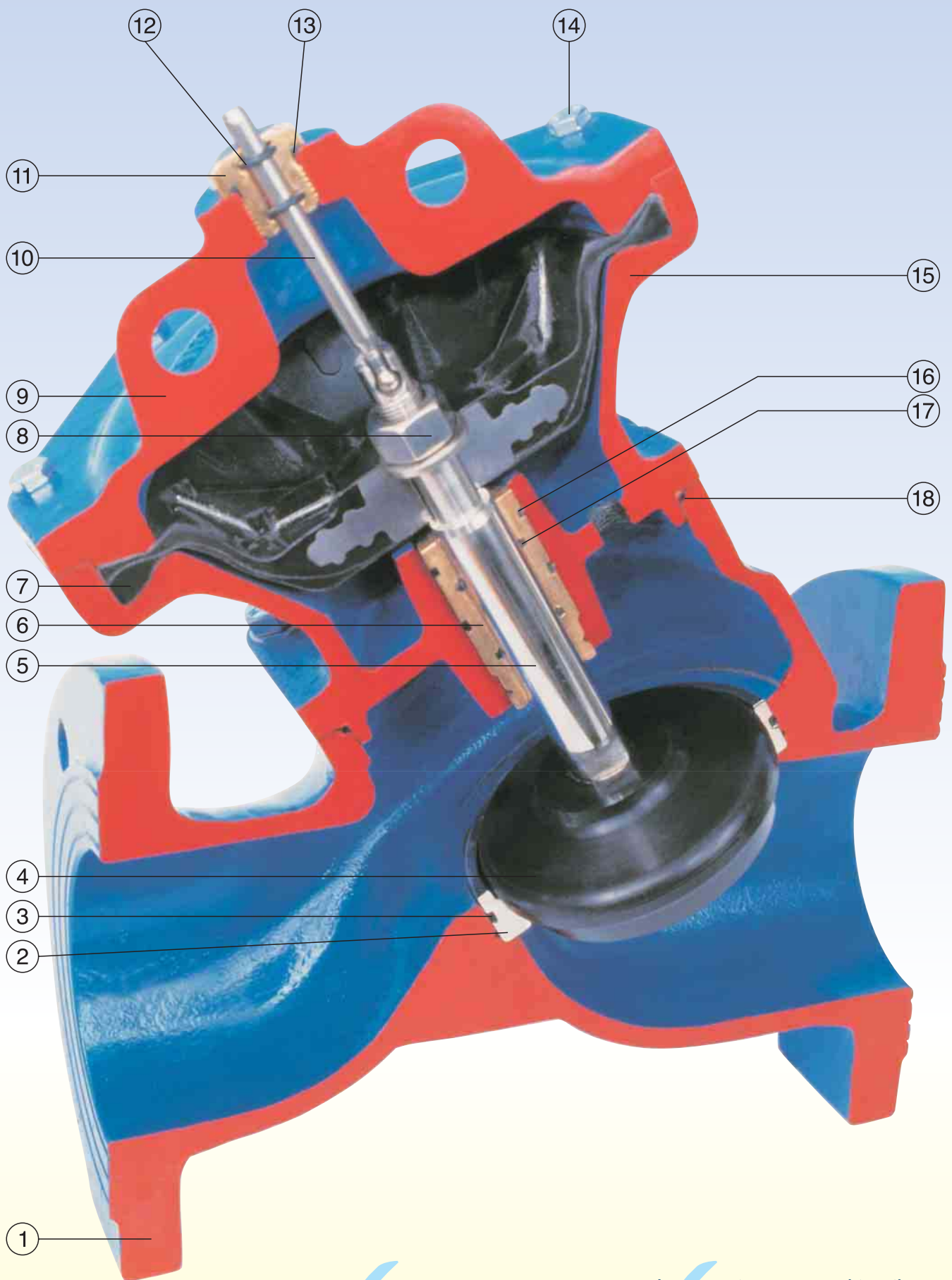

Patent pending rubber diaphragm with special core disc construction for long service life.

Unique universal rubber plug for all work conditions.

Less parts compared to other valves.

Grooved shaft for indicator with ball joint.

Simple design and easy maintenance.

Technical Specifications

RAY - Part list & Materials

No.	Item	Material
1.	Body	Cast Iron
2.	Seat	Stainless Steel
3.	"O" Ring	Nitrile Rubber
4.	Plug	Natural Rubber+Cast Iron
5.	Stem	Stainless Steel
6.	Bearing	Bronze
7.	Diaphragm	Nylon Reinforced Natural Rubber
8.	Nut	Stainless Steel
9.	Cover	Cast Iron
10.	Indicator rod	Stainless Steel
11.	Guide Plug	Brass
12.	"O" Ring	Nitrile Rubber
13.	"O" Ring	Nitrile Rubber
14.	Bolt	Stainless Steel
15.	Lower Cover	Cast Iron
16.	"O" Ring	Nitrile Rubber
17.	"O" Ring	Nitrile Rubber
18.	"O" Ring	Nitrile Rubber

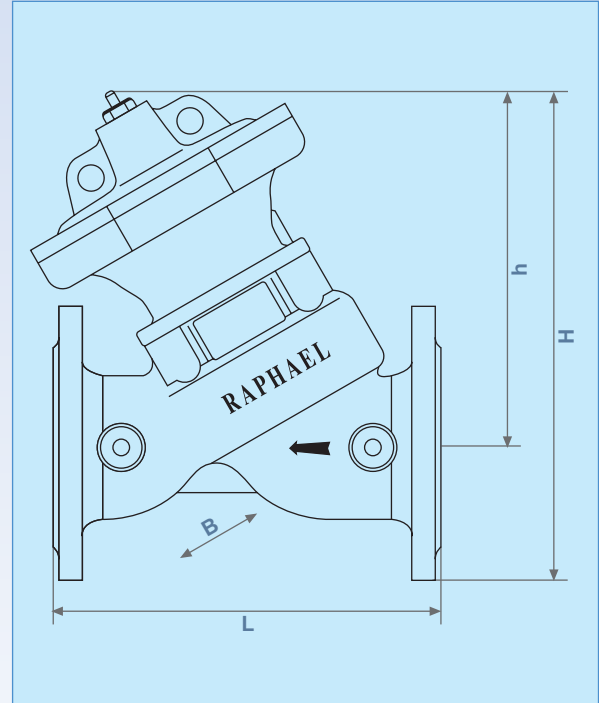

* Other materials and coatings available on request

Nom. Dia.		L	H	B	h	Weight kg.	Connections
mm	inch	mm					
50	2	203	260	125	223	9.7	Threaded
50	2	203	298	165	223	13	Flange
80	3	254	350	200	258	22	Flange
100	4	305	380	230	278	33	Flange
150	6	406	470	280	350	71	Flange
200	8	521	650	380	490	122	Flange
250	10	635	780	460	580	212	Flange

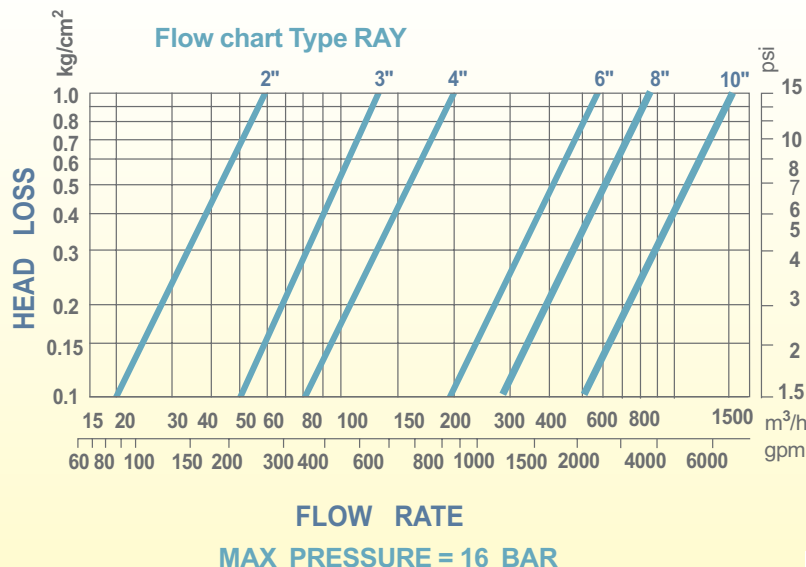

Flow Factor

Size	2"	3"	4"	6"	8"	10"
Cv	70	160	235	670	990	1760
Kv	60	140	200	570	840	1500

$$Cv \text{ or } Kv = \sqrt{\frac{Q}{\Delta P}}$$

$$Kv = 0.856 Cv$$

Cv = Flow factor: gpm at 1psi drop

Kv = Flow factor: m³/h at 1kg/cm² drop

Q = Flow: gpm – m³/h

ΔP = Pressure drop: psi – kg/cm²

Control Volume

Size	2"	3"	4"	6"	8"	10"
Gallon	0.044	0.105	0.180	0.870	1.240	2.040
Liter	0.17	0.40	0.70	3.30	4.70	7.70



RAPHAEL Valves Industries Ltd
 Reg. No. 510718331
 Northern Industrial Zone
 Or Aqiva, P.O.Box. 555
 Israel 3060000

Telephone: +972 4 62 63 555
 Fax: +972 4 62 63 558
 E-Mail: export@raphael.co.il
 Internet: www.raphael-valves.com

RAPHAEL
 BY TALIS

How To Order

RAY

Valve size (inch)

Basic Functions

Additional Features









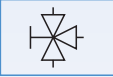

Optional Accsories

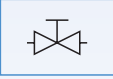
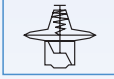
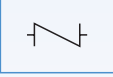
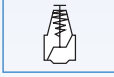
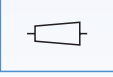
Flange standard

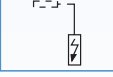
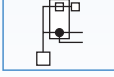



Basic Functions

Control Valve (ON/OFF)	01	Pressure Reducing & Sustaining Valve	68
Level Control Valve	10	Flow Control Valve	70
Pump Control Valve	20	Pressure Sustaining/Relief Valve	80
Altitude Control Valve	40	Surge Anticipating Control Valve	88
Hydraulic Check Valve	50	Anti-burst Valve	90
Pressure Reducing Valve	60		

Additional Features

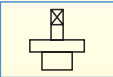
	01 Three-way manual valve		33 Three-way solenoid valve N.C.
	02 Two-way manual valve		42 Two-way Altitude pilot
	05 Check valve		60 Pressure reducing pilot
	11: Needle valve (Open speed control) 12: Needle valve (Close speed control)		70 Diferential pilot (flow control)
	MH Electric level float		73 Three-way diferential level float
	30 Two-way solenoid valve N.O.		80 Pressure sustaining pilot
	31 Three-way solenoid valve N.O.		80 Q Quick two-way pressure relief pilot
	32 Two-way solenoid valve N.C.		3P Three-way multifunctions pilot

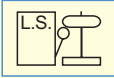
Optional Accsories

	M Mechanical closure stem		I Indicator
	L Large control filter		E Limit switch
	A Inside enamel coated		

Flange Standard

ASTD	1
PN 16	2
ASA 150	3
PN 10	4



RAPHAEL BY TALIS



RAPHAEL Valves Industries Ltd
Reg. No. 510718331
Northern Industrial Zone
Or Aqiva, P.O.Box. 555
Israel 3060000

Telephone: +972 4 62 63 555
Fax: +972 4 62 63 558
E-Mail: export@raphael.co.il
Internet: www.raphael-valves.com